









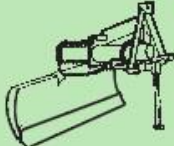

HOWARD

Owner's Manual & Parts List *for* HOWARD



 Rotavator	 Fertiliser Spreader	 Post-Hole Digger	 Multiset Grader
Made in Malaysia	 Rotaslasher	 Mulcher	 Levelling Bucket
	 Rollermower	 Rollerslasher	 Grass Collector

HOWARD Alatpertanian Sdn. Bhd.

2, Jalan Perusahaan Tiga, Batu 20, 48000 Rawang, Selangor Darul Ehsan, Malaysia.







Tel : 603 - 6093 1010 Fax : 603 - 6092 1010

e-mail : howardmy@tm.net.my www.howardmy.com

SAFETY

In the Owner's Manual accompanying each machine manufactured by HOWARD Alatpertanian Sdn. Bhd., Malaysia, (HOWARD), Safety features and precautions to be taken when operating the various implements are duly described.

Some or all of the following information or warning labels are affixed to the machines.

Machine model	Label	Warning / Information
All	Model	Followed by model number embossed on the machine frame..
All	Serial No.	Followed by year of manufacture (alphabet code), and production serial number embossed on the machine frame.
All		General warning that : a) the machine may pose danger to operator and/or surroundings. b) such dangers are described with precautions to be taken in the accompanying Owner's Manual. c) HOWARD has sought to minimise such dangers in compliance with appropriate safety directives, and maintains technical records accordingly. Name and address of manufacturer (HOWARD) and year of manufacture. Beware of flying objects and stay clear of operating machine.
All		
All		
All		
All		
HR/HS/HFS/PHD/ HM/HRM/HSW/ HSC/HA/HMC/HTS		Affixed to rotating universal drive shaft (U/J) linking tractor with implement. Refer also to the safety and maintenance guidelines as described by the OEM U/J manufacturer supplied with each universal drive shaft.
HR/HS/PHD/ HM/HRM/HSC/ HA/HMC	Hot oil	Gearbox oil may become hot after continuous operation.
Various	Others	General informative or safety stickers as appropriate.

DECLARATION OF CONFORMITY

We declare that HOWAD implements/machines have been manufactured in conformity with EU Council Directive 2006/42/EC - L 157.

Kuala Lumpur, Malaysia - 12th January 2010.



.....
Mohd Rafi bin Jamlus
(Production Manager)



.....
Balasubramaniam Vailu
(QA - Inspection)



.....
Diana Bartolome
(ISO MR)

HEALTH

The safety and health of operators and fitters is generally the responsibility of the owner of the machine. However, HOWARD has strived to design its implements so as to minimise risks.

Likewise, in the manufacturing process, employee safety and health is monitored in accordance with Malaysian law and HOWARD's internal production management systems.

ENVIRONMENT

Environmental assesment is carried out on HOWARD's products and manufacturing processes, as described in the company's 9001 ISO management procedures.

WARRANTY

We undertake to supply , free of charge, new parts in place of parts which break or wear excessively through faulty material or bad workmanship within SIX months after delivery, provided such faulty parts are returned to us carriage paid, for examination. But we are not liable for labour, or any loss or damage direct or consequential, nor responsible for any accident, or in any way for the effect of any accident, whether due to defective material, workmanship or otherwise, and our guarantee does not apply to defects which in our opinion are caused by accident, wear or tear, misuse or neglect, including the use of unsuitable or dirty lubricants, or by interference with the construction of the machine as completed by us.

Your obligation as the Owner is to give the machine proper attention and care, in accordance with the guidelines given in this OWNER'S MANUAL PARTS LIST>

We reserve the right to make changes in design, and changes or improvements upon our product, without imposing any obligations on us to install the same on products there-to-fore manufactured.



Rotavator BEAVER 16



Serial number

The Serial and Model Numbers are stamped on the frame of your **ROTAVATOR**.

For future reference record the numbers below.

ALWAYS quote them when ordering spareparts.

MODEL No. _____

SERIAL No. _____

Date Purchased _____

We hope you will be happy with your **HOWARD** Rotavator.

Treat it well - and it will serve you diligently for many years to come.

Should you encounter problems - or have questions in respect of soil cultivation or seedbed preparation - please feel free to contact us or consult our dealers.

Notes:

1) Continuous R & D may result in the technical contents of this Manual not always being identical to the specifications for the latest model delivered. **HOWARD** in ASIA since 1962.

2) For more details and technical support, consult our web-page:
www.howardmy.com

HOWARD Alatpertanian Sdn. Bhd.

2, Jalan Perusahaan 3
Batu 20, 48000 RAWANG
Selangor, W. Malaysia

Tel: (6 03) 6093 1010

Fax: (6 03) 6092 1010

E-mail: howardmy@tm.net.my

Spare Parts Direct Line: (6 03) 6093 6363

! SAFETY PRECAUTIONS & OPERATING INSTRUCTION !

Before use

#Ensure operators have read and are familiar with the instructions contained in this manual.

#Consult the Tractor Manufacturer's Manual for instructions on mounting implements and safe working methods.

#Ensure the ROTAVATOR is standing on firm level ground and securely supported.

#Ensure the ROTAVATOR is set parallel to the ground, when looking from the back of the machine - this is to ensure uniform depth of cultivation.

#Ensure the BLADES are fitted correctly forming the pre-set "Scroll Pattern". This ensures that they enter the soil at regular intervals to even out the load on the transmission.

#Make certain that all guards, covers, warning labels and safety devices are correctly fitted and operative.

#Ensure the work area is clear of bystanders.

#Inspect the work area for obstructions which may constitute a hazard.

#Disengage all clutches and shift into neutral prior to starting the tractor engine.

During use

#Engage the PTO drive before moving forward and lowering the ROTAVATOR to the ground, at a speed suitable for prevailing conditions.

#As a general guide, the more unfavourable the conditions are, the SLOWER the tractor forward speed should be.

#Observe all safe driving procedures such as reducing speed on slopes and sharp turns.

#Avoid working on ground where there is a risk of the tractor overturning.

#Do not operate across the face of slopes.

#Avoid disengaging the tractor transmission before raising the ROTAVATOR from the ground.

#When making sharp turns, while operating the ROTAVATOR, ALWAYS lift the machine clear of the ground and disengage the PTO drive.

After use

#Disengage the PTO drive when transporting the ROTAVATOR or not in use.

#Inspect the ROTAVATOR for damage and that its rotor has not become clogged with mud/soil, strings or other debris. Clean the machine thoroughly before storage.

#Check that all bolts, nuts and fasteners are tight. Replace all worn, broken or bent blades, if any.

#Carry out lubrication and maintenance as detailed in this manual.

Always

- Wear safety or substantial footwear.
- Avoid loose clothing which may be caught in moving parts.
- Wear earmuffs or earplugs. Prolonged exposure to noise can cause impairment or loss of hearing.
- Wear gloves when handling worn implements or parts with sharp edges.
- Use the implement only for the purpose for which it was designed and in accordance with the instructions contained in this manual.
- Ensure the Rotavator is not operated by children or untrained persons.
- Interpret “left” or “right” as the left or right hand of the operator when sitting on the tractor seat and facing forward.

NEVER

- Use your Rotavator unless the safety guards are in place.
- Check oil levels whilst the implement is running.
- Attempt to clear any obstruction around the spindle or carry out cleaning, lubricating, adjustments or repairs to a mounted implement, unless the tractor engine is stopped and the implement is propped correctly or resting on firm level ground.
- Leave the tractor seat unless the implement is lowered, the PTO drive disengaged, the gear shift in neutral, the brake applied, the engine stopped and the ignition key removed.

**BE A SAFE OPERATOR
BY THINKING – BEFORE
ACTING**

PRINCIPLE OF ROTAVATION

What is ROTAVATION?

Rotavation is the direct application of tractor engine power through a rotor and hoe blades of a special design to soil preparation in establishing the ideal growth conditions for seedlings and seeds.

The working of the soil by Rotavation gives control over weeds and serves to mix fertiliser, lime, crop residues and other organic matter with the soil, producing good physical conditions for composting, formation of humus and rapid seed germination.

Compared with other methods of soil preparation (disc or mouldboard ploughs), Rotavators provide a superior and even soil mixing rate throughout the tilling depth, allowing the soil with the best structure to remain in the surface layers where it is most needed.

FLEXIBILITY of ROTAVATION

Farmers will know when the timing is right for soil preparation, and will know the condition of the land, the purpose and type of tilth required.

Rotavation allows optimal possibilities and combinations to achieve the results desired:

- a) Rotor speed (single speed or selecttilth speed gearbox)
- b) Blade configuration (4 or 6 per flange)
- c) Trailing board position (lowered or raised)
- c) Length of "bite" (tractor travel speed)

LIGHT SOILS are inclined to disintegrate, resulting in loss of water retention capability. As such it is recommended to rotavate light soil areas before drying out - and choose a coarse tilth, i.e. slow rotor speed, raised trailing board and fast tractor speed.

CLAY SOILS should not be rotavated when too wet (balling up) nor too dry (dust), and should generally be worked to a finer tilth, using above parametres.

How fast can I rotavate?

Tractor speeds of 3 - 6 km/hour will apply to most conditions and will provide 0.5 - 1.0 ha prepared land per hour.

Does a Rotavator cause a hard soil pan?

Unlike a plough, the weight of the machine does not rest on the soil-engaging cutting edges, and the rotating blades exert no downward pressure. The scroll pattern of the blade configuration provides forward momentum thereby also reducing the tractor horsepower required. Rotavator blades are scientifically shaped to have a cutting and lifting action, with the heel of the blade never wholly touching the soil at any stage.

The texture of rotavated soil absorbs and retains up to three times as much moisture as conventionally ploughed soil. This is particularly valuable during dry seasons and in areas with low rainfall. Surface run-off and soil erosion is considerably minimised on rotavated land.

Fine, medium or coarse tilth can be obtained to suit the crop, the soil and the climate - in accordance with recognised principles of agricultural soil management.

HOWARD invented Rotavators - and has been actively involved in mechanisation of soil preparation in Southeast Asia since 1962.

Does rotavation cause erosion?

Any soil-engaging implement carelessly used can cause erosion. But a seedbed produced by rotavation will absorb and retain three times as much rainfall as soil cultivated by ploughs.

Does rotavation increase weeds?

In a controlled way, yes, by finely chopping and providing ideal growth conditions for weeds. But rotavation also provides the answer - and the best known method of mechanical weed control. Eradicate perennial weeds during a fallow period by letting the Rotavator bring the roots to the surface to wither and die. Grass kill and mulch is easily obtained at controlled depths, making the Rotavator useful for multiple agricultural purposes.

SPECIFICATION OF YOUR ROTAVATOR

Specification	B-16/105	B-16/125	B-16/155	B-16/180
Working width, cm	105	125	155	180
Working depth, cm	16			
For Tractor, Hp	15-45			
Three point linkage	CAT 1/11			
Universal driveshaft	A4 w/Shearbolt			
Gearbox	Single Speed			
Rotor speed at 540 rpm PTO	210			
Side drive	Chain & Sprocket			
Number of blades	24	30	36	42
Offset, max, cm	-	11	11	22
Weight, Kg	200	230	260	290

New Machine

Power Take-Off Drive Shaft & Safety Device

The ROTAVATOR is supplied with a PTO Drive Shaft complete with Shear Bolt Torque Limiter. For transport reason, the Outer Half Shaft c/w PTO Yoke is taken off and must be refitted before use.

Lubrication & General

With the ROTAVATOR standing level, ensure the following preparatory work has been done:

- 1)The chaincase filled to the level plug (0.75L). Use SAE 140 gear oil.
- 2)The gearbox filled to the dipstick mark (0.7). Use SAE 140 gear oil.
- 3)All oil and grease points to be lubricated.
- 4)All bolts and nuts tightened (re-tighten after first 8 hours' works).



SERIOUS DAMAGE CAN RESULT FROM FAILURE TO CARRY OUT THE ABOVE PROCEDURES.

COMMISSIONING OF YOUR PTO DRIVEN ROTAVATOR

Your ROTAVATOR has been designed to work in a wide variety of conditions, and is a very simple machine to use. The following adjustments will ensure optimum performance in all conditions.

Attaching the Rotavator to the tractor

The PTO Drive Shaft must be set to a safe working length to ensure the inner shaft does not "bottom" or separate from the outer shaft under all conditions of use and transport.

To determine the correct mounting position: With the Rotavator on a firm level surface, the Depth Control equipment should be adjusted until the Gearbox Input Shaft is horizontal (see Fig. 1)

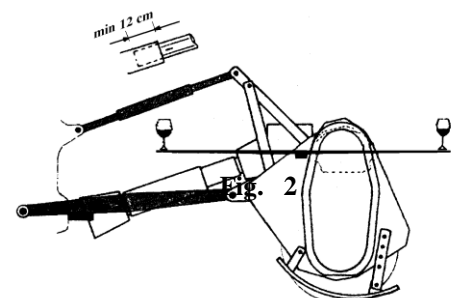
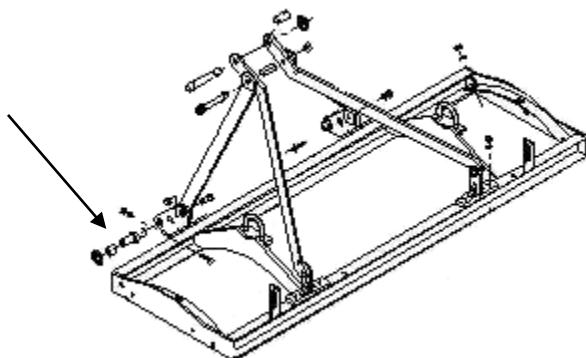

Fig. 1

Position the tractor at a distance from the Rotavator to give 12 cm minimum engagement of the inner half of the PTO Drive Shaft in the outer half when connected to the tractor. This establishes the safe working length of the PTO Drive Shaft for connection to the tractor.

Position the tractor lower link ball joints in line with the Hitch Pins' holes in the Mounting Brackets (see Fig. 2). Connect the tractor lower links, left hand link first, securing with Hitch Pins and Cotter Assemblies, adjusting the right hand tractor lift arm if necessary. Fit the tractor upper link and secure. Attach the PTO Drive Shaft to the tractor ensuring the quick release pin engages the spline shaft groove. Attach the PTO Drive Shaft Guard Chains to the tractor and Rotavator.



Attach stabilizer bars or check chains to limit sway to 3 cm. Adjust tractor linkage to level the Rotavator laterally and longitudinally (see Fig. 3)

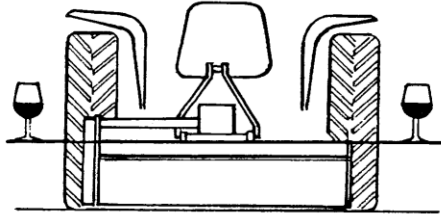

Fig.3

Before engaging the tractor PTO, lift the Rotavator on the hydraulic lift linkage until the lowest cutting edges of the blades are 230 mm above ground level and set the limit stop on the hydraulic lift control quadrant (see Fig. 4).

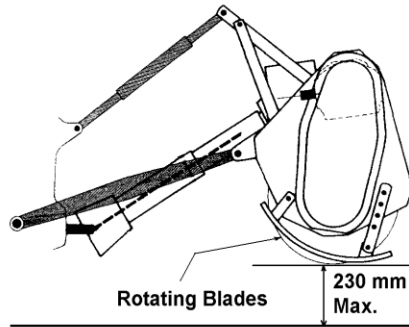

Fig.4

Finally check that during transport and use, the PTO Drive Shaft does not "bottom" or separate and that the maximum height of 230 mm is not exceeded.

Should it not be possible to obtain the aforementioned setting with your tractor, SEEK ADVICE; it may be necessary to reduce the length of the PTO Drive Shaft by cutting of equal amount from both Inner & Outer Cardan Tubes with a hacksaw.

OPERATING INSTRUCTIONS

Operational Information

By simple adjustments, the ROTAVATOR will produce a range of tilths in most soil types and handle various cultivation techniques e.g. weed control, seedbed preparation, trash and chemical incorporation, etc.

As a general principle, fine tilths are produced by a combination of slow tractor speeds, and a lowered trailing board. Conversely, coarse tilths are produced by fast tractor speeds, and raised trailing board (see Fig. 5)

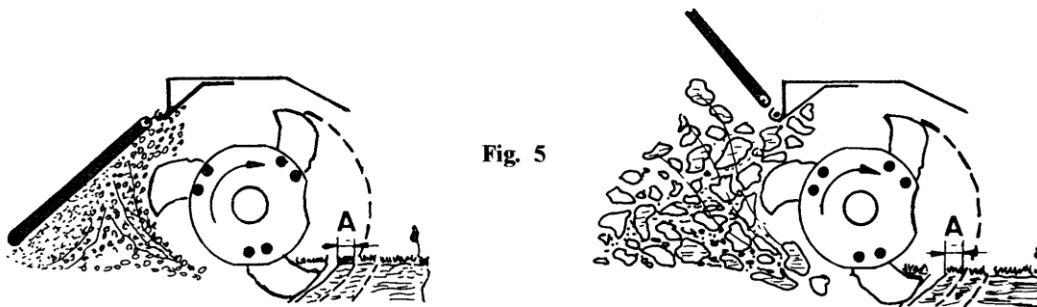

Fig. 5

As an alternative to the standard 3-blade, a 2-blade rotor configuration can be used which reduces the tendency for clogging and soil balling (see Fig. 6). The 2-blade configuration is specially suited to sticky soil conditions,

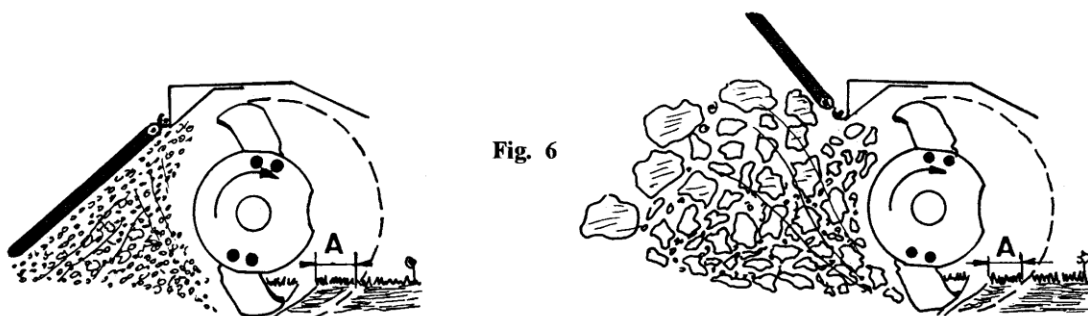

Fig. 6

trash incorporation and the production of a rough cloddy finish.

Intermediate grades of tilth from coarse to fine can be obtained by:

- Adjusting the height of the trailing board which by impact shatters the blade cut “clods” (A).
- Raised trailing boards also deposit weeds and trash on the surface to wither, whilst lowered trailing boards bury trash as well as having a leveling effect on the soil.
- Increasing or decreasing the tractor travel speed which alters the size of blades cut “clod”(A). Higher travel speeds may also be used for shallow work on previously broken ground or scalping passes for weed control.

Working Instructions

Set the depth control skids to the required tillage depth. Select a trial trailing board position to give the type of tilth required. Engage the tractor PTO and drive forward, progressively lowering the Rotavator into the ground. Proceed for a short distance and check whether the resultant tilth is satisfactory and the tillage depth is uniform across the rotor width. If not, make the appropriate adjustments to produce the required tilth.

If in doubt, consult the Operators Checklist which provides remedies for most operational problems.



**THE ROTAVATOR SHOULD NEVER BE LOWERED
WHILST THE TRACTOR IS TURNING.**

OPERATOR'S CHECKLIST

Insufficient Depth Obtained.

- Adjust depth control skids.
- Insufficient power use lower tractor gear, reduce rotor speed.
- Chaincase on hard soil. Further passes required.
- Blades "trowelling" (rolling over ground), increase rotor speed or use lower tractor gear.
- Blades incorrectly mounted.

Tilth too fine.

- Raise trailing board
- Reduce rotor speed.
- Use a faster tractor gear.
- Convert to 2-blade configuration.

Tilth too coarse.

- Lower trailing board.
- Increase rotor speed.
- Use lower tractor gear.
- Wait until soil is drier if it sticks.
- Convert to 3-blade configuration..

Blades "Balling up" with soil.

- Ground too sticky for working.
- Increase rotor speed
- Raise trailing board
- Decrease tractor speed
- Convert to 2-blade configuration

Excessive Blade Wear.

- Reduce rotor speed
- Replace loose or bent blades

Excessive Blade Wear.

- obstacles entangled in blades
- Blades incorrectly mounted with no scroll effects or blades fitted with blunt edge leading
- Broken, bent or missing blades
- Bent rotor

Obvious Points.

- ROTAVATOR not level – cutting too deep on right side. Shorten right hand tractor lift rod or adjust depth control skid.
- No overlapping – drive closer to last run.
- Working on hillsides – Work up the slope if possible. If lateral work from the top to bottom in order to limit any terracing effect.

Rotavating.

- when operating the Rotavator, the most suitable practise is to work in "lands".
- The ROTAVATED ground should always be to the right of the driver.
- ROTAVATING the field headlands should not be carried out until the "lands" have been completed.
- Always raise the Rotavator before turning.

ROTAVATING PROCEDURE

Rotavate the "lands" first and the "headlands" last.

WETLAND (Fig. 7)

1. When rotavating paddy fields, cultivate from the sides.
2. Work anti clockwise.
3. Cross bunds diagonally right to left.

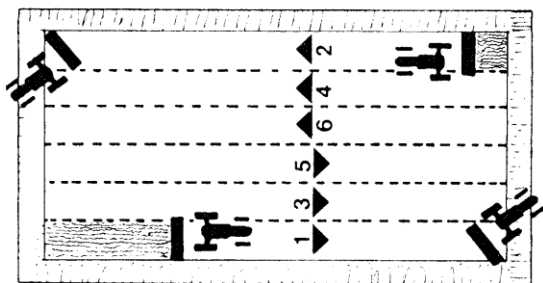

Fig. 7

DRY LAND (Fig. 8)

1. Cultivate outwards from the middle of the field.
2. Work clockwise.
3. Furrows and ditches may be filled by driving the right hand tractor wheels on the edge of the furrow with the right Rotavator blades over the furrow itself.

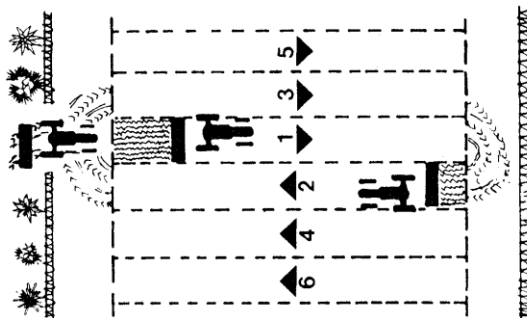

Fig. 8

Always drive with rotavated ground **ON THE RIGHT**, except when finishing the headlands, which should be started against the bund/fence - and worked anti clockwise.

AFTER COMPLETING A PASS, ALWAYS RAISE THE ROTAVATOR BEFORE TURNING.

SOIL

The amount of clay present in heavier soils gives them cohesion.

Tilth in light soils will tend to be finer, whereas a greater variety of tilth - coarse, medium, fine - is obtainable in heavier soils.

The farmer will easily recognise when the soil is in a suitable condition for tillage, and will be able to determine the best choice of tilth based on the flexible options available in rotavation, i.e. blade type and configuration, position of trailing board, rotor speed and tractor travel speed.

ROTOR SPEED

ROTAVATOR MHR16 has only one rotor speeds of 210 rpm at tractor 540 rpm PTO. Use tractor travelling speeds in combination with this speed to achieve the types of tilth you desire.

Two Blade Configuration

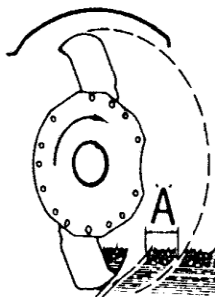

Blade Bite 'A' must not exceed 18 cm.

Three Blade Configuration

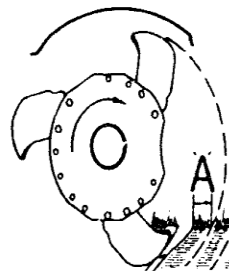

Blade Bite 'A' must not exceed 15 cm.

TRACTOR TRAVELLING SPEED

Higher speeds may be used for shallow scalping passes for weed control or broken ground.

For normal soil tillage, travel speeds of 2 - 4 km/hour usually provide the best tilth.

CULTIVATION RATES

Tractor Travel Speed – Km/Hour	1	2	3	4	5
Rotavator Model	Hectares per Hour				
B-16 / 125	0.11	0.21	0.32	0.42	0.52
B-16 / 155	0.13	0.26	0.40	0.53	0.66
B-16 / 180	0.15	0.31	0.46	0.60	0.75

with allowance for "Headland" work and turning.

GEARBOX and CHAINCASE

If there is sign of oil leak, check oil level IMMEDIATELY. Otherwise, daily check would suffice, preferably before commencement of the day's work. Top up with SAE 140 Gear Oil if necessary and tighten all fasteners, dipstick, breather plug and Oil Lever Plug.

If machine is newly installed, AFTER FIRST 50 HOURS OF OPERATION, flush and refill with SAE 140 Gear Oil until it reaches the maximum Oil Level Mark on the Dipstick (or Oil Level Mark in the Gearbox Housing) or flows out of the Oil Level Plug on the Chaincase (see Fig. 27).

Chaincase

After every 500 hours, the chaincase should be thoroughly cleaned out. With the Depth Control Wheel and Ground Skid removed (if they are fitted), slacken the chain adjusting screw, then unscrew all the bolts securing chaincase to backplate allowing the chaincase oil to drain out from the joint. Remove the cover, ensuring that gasket is not damaged, and wash out the inside of the chaincase and the chain, with kerosene. Reassemble and fill with SAE140 gear oil through the top plug in the chaincase until oil flows out of the Oil Level Plug at the bottom of the Chaincase.

Drive Chain

Correct tension of the drive chain is as important as proper lubrication. To check chain tension, remove the inspection plug on the rear side of the chaincase and check the movement of the chain, using a screwdriver or a piece of hooked wire. The total back and forward movement should be approximately 10mm (3/8").

If the chain needs tightening, unscrew the locknut on the chain adjusting screw on the leading edge of the chaincase, and screw up the adjuster until the required tension is obtained. Retighten the lock nut.

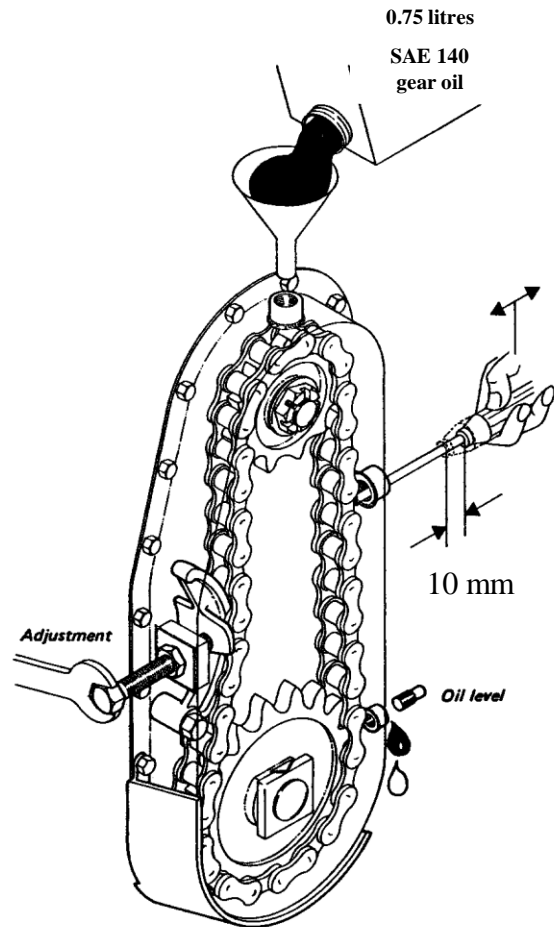

Fig. 27

ROTOR DRIVE SHAFT / STUB AXLE

Daily check for oil leakage in these two areas. If oil leaks, take IMMEDIATE action to clean the "wedged" seals of all foreign materials, replace worn seal kits and / or bearings. Loose nut holding the Rotor Drive Shaft or Stub Axle and blocked breather in the Jackshaft Housing may also be a cause to this problem.

STUB AXLE

After every 500 hours, the Stub Axle housing should be removed and thoroughly cleaned out with kerosene. Replace the housing and refill with 190 ml SAE140 gear oil.

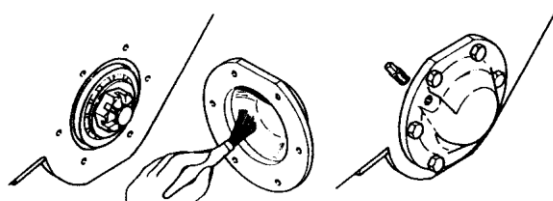

ROTORS

ROTAVATOR'S are fitted with Standard Rotors, but can be supplied with **interchangeable rotors**.

The **interchangeable rotors** can be rapidly transposed in approximately 20 minutes. The rotors available will produce a range of tilths on a variety of soil types and moisture contents with maximum economy provided HOWARD BLADES are used.

Badly bent, worn or broken blades will impair efficiency and should be replaced immediately using genuine HOWARD BOLT ASSEMBLIES which are specially manufactured to a high tensile strength specification.

When replacing blades, ensure the scroll pattern is maintained.

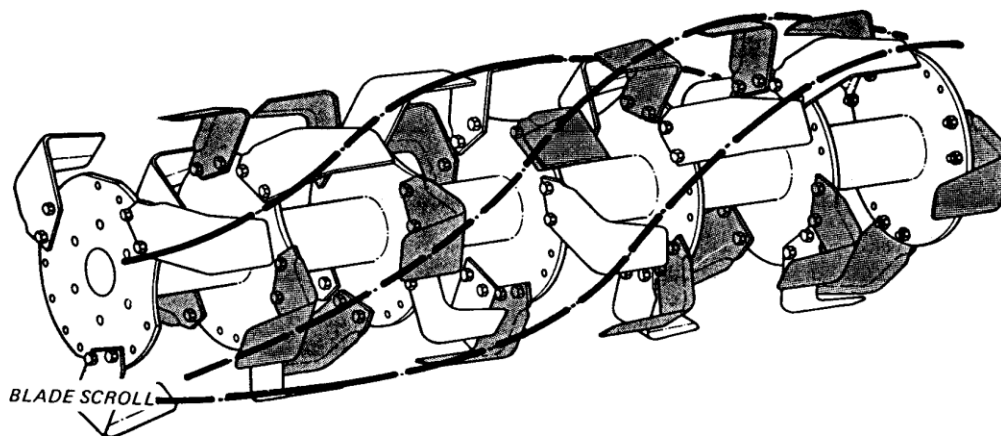

Blading Standard Rotor

Firstly identify left and right hand blades. Refer Fig. 34 on the left. Blade bolts must have the heads located against the blade and the washers and nuts against the rotor flange. Use only ORIGINAL-HOWARD-BLADES and HOWARD-BLADE-BOLTS. Always attach blades to the left side of the rotor flange, except the right hand end flange, where the blades are fitted on the right side.

When correctly fitted, the blades must form a "scroll" pattern. This ensures that they enter the soil at regular intervals to even out the load on the transmission. When replacing worn blades, remove one blade and fit the new one in its place before proceeding to the next. This will ensure that the blade "scroll" pattern is maintained.

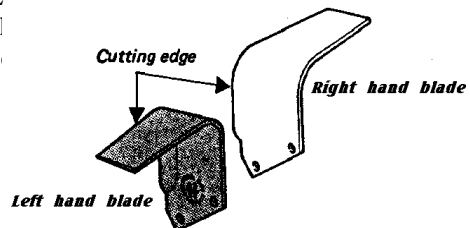

3 Blade Formation:

Left Hand Blades use

Hole No: 1 + 2; 5 + 6; 9 + 10

Right Hand Blades use

Hole No: 3 + 4; 7 + 8; 11 + 12

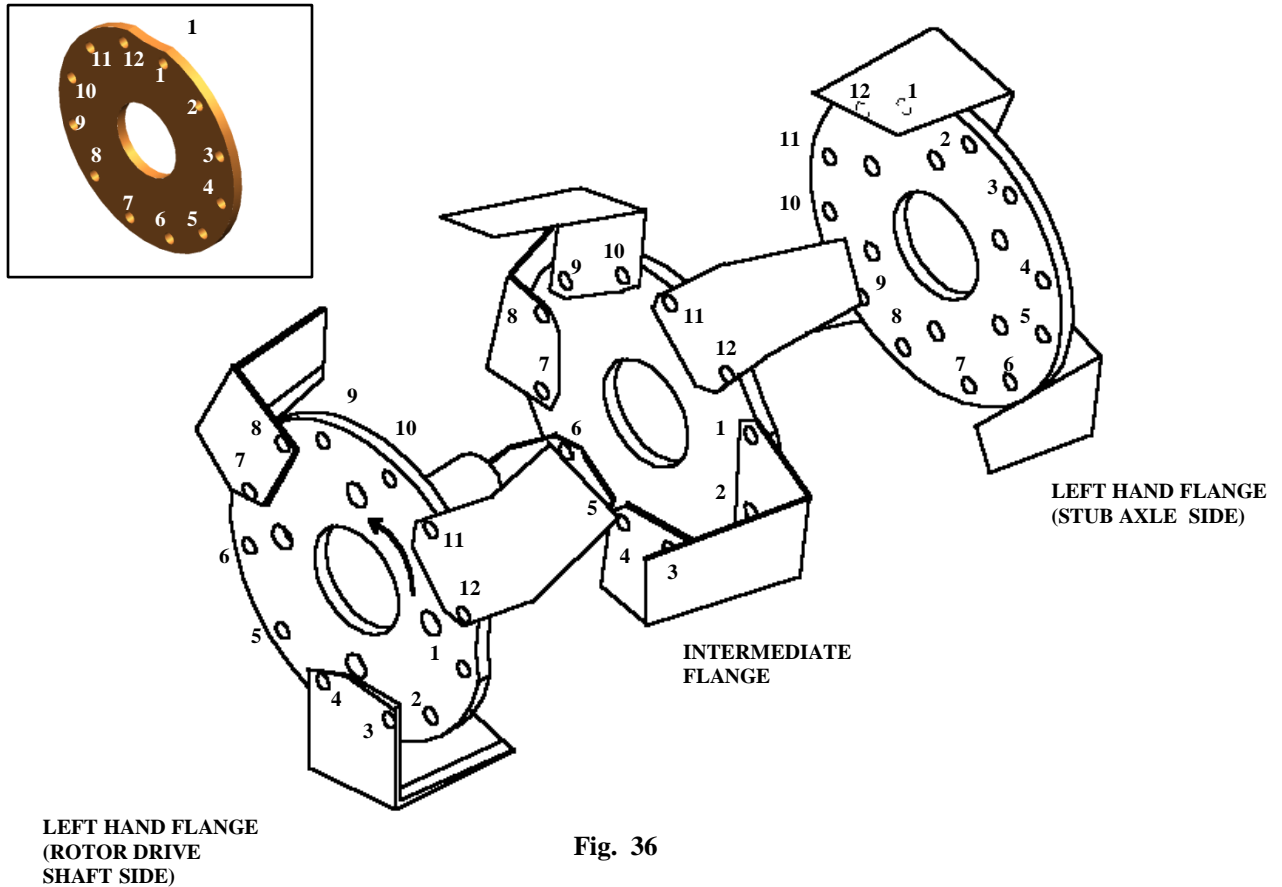

Fig. 36

Fit a right hand blade to any pair of pre-defined/numbered holes in the left hand End Flange.

Move to the next flange and fit a right hand blade using the pair of holes which are slightly ahead of the holes occupied by the blade in the end flange.

Proceed along the rotor fitting one right hand blade on each flange with the exception of the right hand End Flange which carries left hand blades only. Ensure that each blade is slightly in advance of the blade on the previous flange.

Check that the blades form a scroll pattern

On the second flange from the left, fit a left hand blade immediately in front of the right hand blade already in position. Continue along the rotor including the right hand End Flange.

Check the scroll pattern.

For a 3-Blade Rotor repeat the procedure fitting right and left hand blades alternately until there are 6 blades on each flange (except the left and right end flanges).

Tighten all blade bolts to 100 Nm.

Changing rotors

To change rotors, the ROTAVATOR should be lifted 75 mm above the ground on the tractor 3 point linkage and firmly supported for safety.

Take out the **6 bolts** (A) securing the rotor to the Rotor Drive Shaft on the left hand side of the machine and the **6 bolts** (B) securing the rotor to the Stub Axle on the right hand side plate of the machine (see Fig. 37). Loosen the bolts securing the right hand Stub Axle Plate to the Body.

The rotor can now be removed.

To fit an alternative rotor, reverse the sequence of operation.

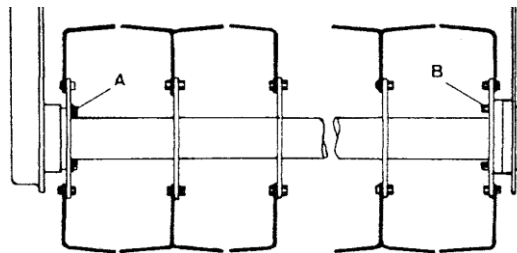

Fig. 37

Worn or bent blades

Daily check for missing, worn or bent blades, replace if necessary.

Rotor Options

Standard Rotor

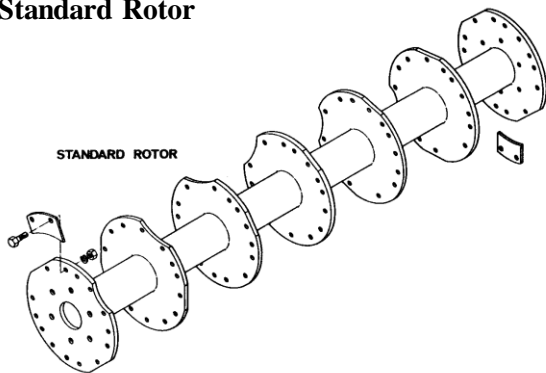

Renovating Rotor

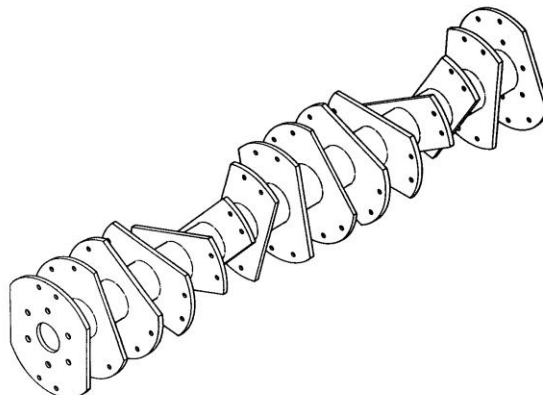

Blade Options

Types of Blades

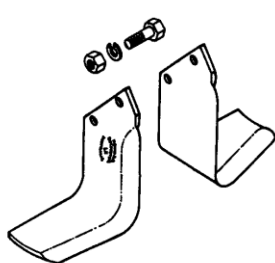

Standard L Blades

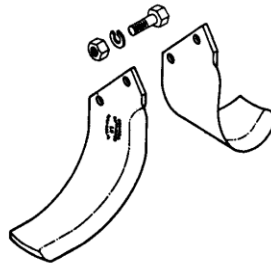

Speed Blades



Renovating Blades

Weed-cutters

Small weedcutter plates are provided at each end of the rotor to prevent weeds and long grass wrapping around the rotor ends. These plates are slotted and should be adjusted so they just clear the back of the blades on the end flanges of the rotor when operating.

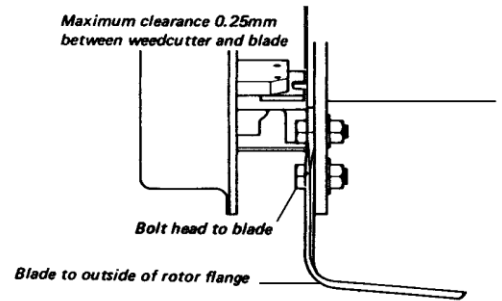

Depth control

For model fitted with side mounted depth control skids: **Fig. 44** illustrates the attachment of the left hand skid. Slacken nut (A) on the adjusting bar (B). Position the skid (C) to the required depth of work and re-tighten the nut

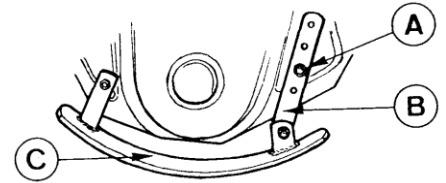

Fig. 44

Fasteners

Daily, ensure all bolts and nuts are properly tightened.

Weekly, spray hinges, height adjusters and fasteners with penetrating lubricant.

Service Diagnosis

Assembly	Defect	Possible cause
PTO Drive Shaft	<i>Vibration</i>	<ul style="list-style-type: none"> -due to twisted inner or outer shaft. -Collapsed needle rollers in Cross Journal -Lifting machine too high when PTO Drive Shaft still engaged.
Shear Bolt Torque Limiter	<i>Frequent Shearing of Shear Bolt</i>	<ul style="list-style-type: none"> -due to incorrectly torque setting; use original HOWARD Shear Bolts & Nuts to ensure correct torque setting. -Due to excessive shock load; operate ROTAVATOR at FULL SPEED before slowly lowering it on to the ground.
Gearbox Assembly	<p><i>Excessive noise</i></p> <p><i>Oil leaking from gearbox</i></p> <p><i>Insufficient oil in gearbox</i></p>	<ul style="list-style-type: none"> -due to incorrect backlash between crownwheel and pinion. -worn or loose bearings on pinion shaft -worn or loose bearing on jackshaft -due to worn or damaged input shaft seal -blocked or damaged breather in gearbox or jackshaft housing -due to oil leaking from gearbox -damaged or worn crownwheel bearing seal
Chaincase	<p><i>Excessive noise</i></p> <p><i>Excessive oil in chain case</i></p>	<ul style="list-style-type: none"> -due to incorrect backlash between -bent rotor -worn chain and sprockets -loose or badly worn chain skid -collapsed rotor drive bearing -blocked breather in jackshaft housing -damaged or worn crownwheel bearing seal
Backplate	<i>Twisted</i>	<ul style="list-style-type: none"> -machine was not lifted off the ground when making sharp turn
Rotor Drive Shaft & Stub Axle	<i>Oil leaking from seals</i>	<ul style="list-style-type: none"> -due to scorched or excessive worn seal facings -collapsed rotor drive or stub axle bearing -foreign material in oil holding seal faces apart -damaged 'O' rings in seal assembly -loose rotor drive shaft or stub axle nut -blocked breather in jackshaft housing
Rotor & Blades	<i>Rotavator "Bumping"</i>	<ul style="list-style-type: none"> -incorrect blade configuration -bent blades -broken or missing blades -bent rotor -obstacles entangled in blades -mixed usage of HOWARD and Non-Howard Blades

MHR16

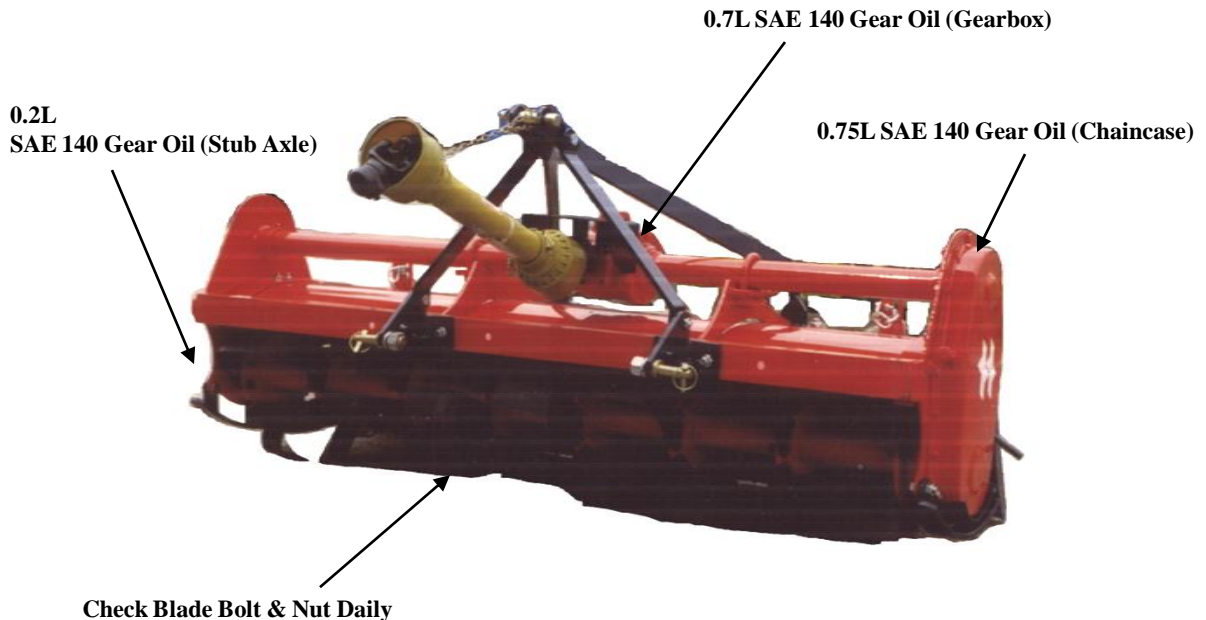

New Machine

After Four Hours Work

1. Check chain adjustment
2. Check all bolts and nuts and tightness

Daily

1. Grease the cross journals, using Lithium base grease:
Notes: It is essential that the lubricant is forced out of all four cups under pressure from the gun, the cross journals should be examined for blocked galleries before continuing work.
1. Separate the two sections of the Drive Shaft, clean and then liberally smear the sliding surfaces with graphite or Molybdenum-Disulphide grease.
2. Check and adjust weed cutters
3. Tighten all blade bolts, straighten any bent blades.
4. Tighten any loose bolts
5. Check for signs of undue clutch slip

Weekly or Every 50 Hours Worked

1. Check Gearbox oil level.
2. Check Chaincase oil level.(Remove the lower plug from the rear of the Chaincase). NOTE: Level should be checked when the blades are on the ground and the main frame is parallel to the ground.
3. Spray the Trailing Board hinges and Skid pivot bolts with penetrating lubricant.
4. Check and tighten all main frame and mounting bolts and nuts.
5. Check Stub Axle oil level
6. Check chain adjustment

Every 500 Hours Worked

1. Drain Gearbox, flush out and refill with 0.7 litres SAE140 gear oil.
2. Remove Chaincase, flush out and refill with 0.75 litres SAE140 gear oil
3. Remove Stub Axle housing, flush out and refill with 0.2L SAE140 gear oil.
4. Check cross journal needle bearings. Replace Cross Journal if bearing worn.

MAINTENANCE OF UNIVERSAL DRIVESHAFT

- Recommended use high quality grease LITHIUM BASE (type NL G2).
- Make sure to pump grease into the cross journal nipple until the grease came out from all cups.

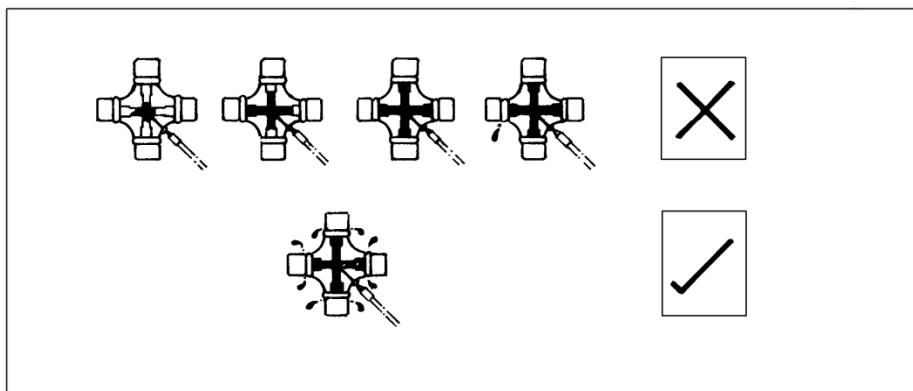

- Make sure to dismantle both shaft assembly and then to brush at surface of inner and outer shaft with GRAPHITE POWDER OR MOLYBDENUM DISULPHIDE GREASE.
- Difficulty to move the inner and outer shaft when operation will cause the serious damage to the shaft or output tractor shaft. If the surfaces of inner and outer shaft are dirty, we advise customer to clean it twice per day.

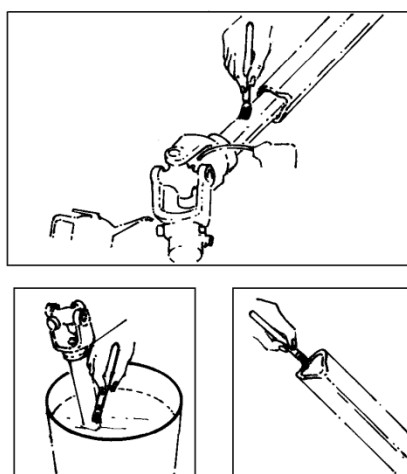

- Please refer to the PTO owner's manual for further understanding.

ROTAVATOR B-16
Universal Drive Shaft A4
T400560EN112B02

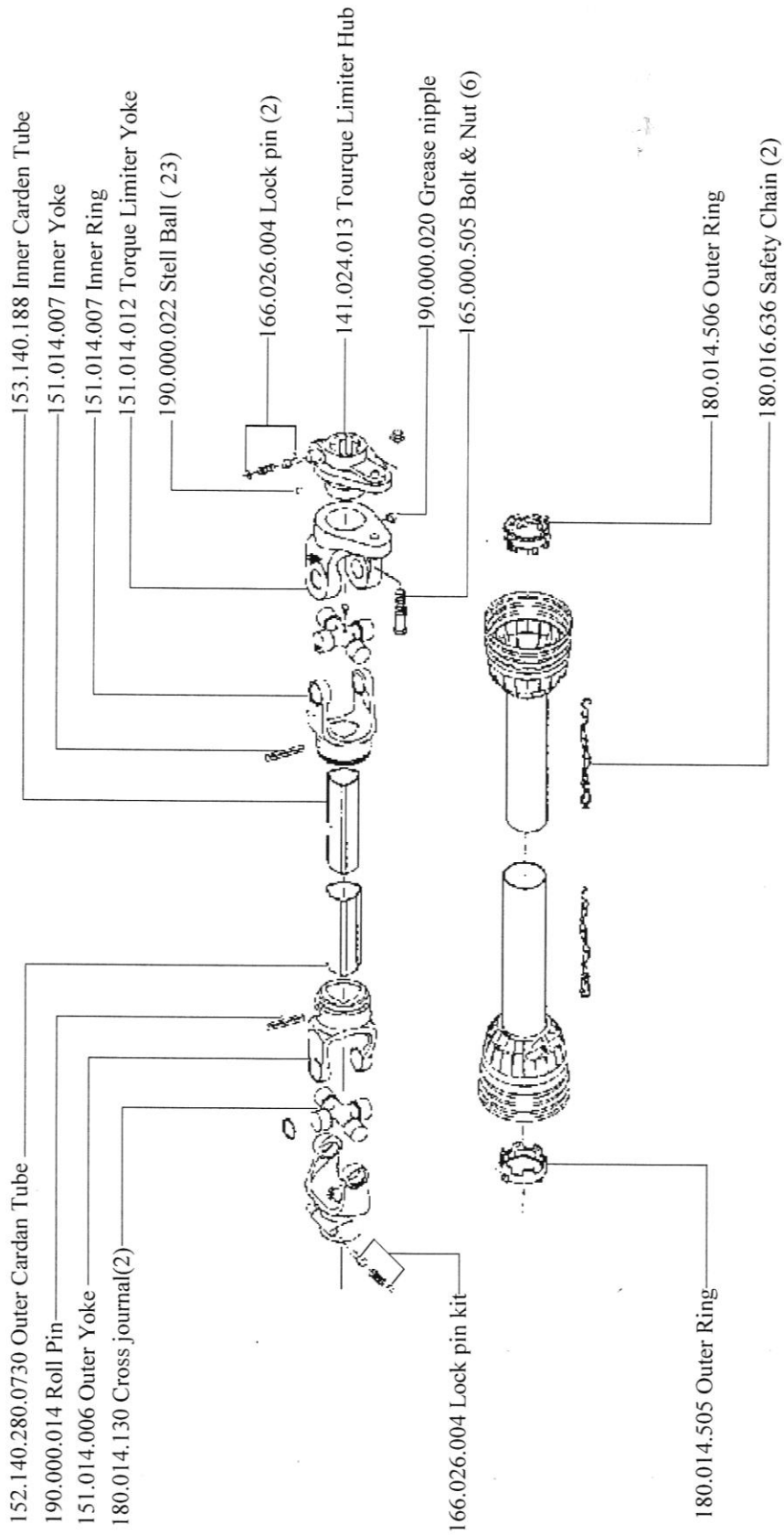

ROTAVATOR B-16
Single Speed
926.100.910

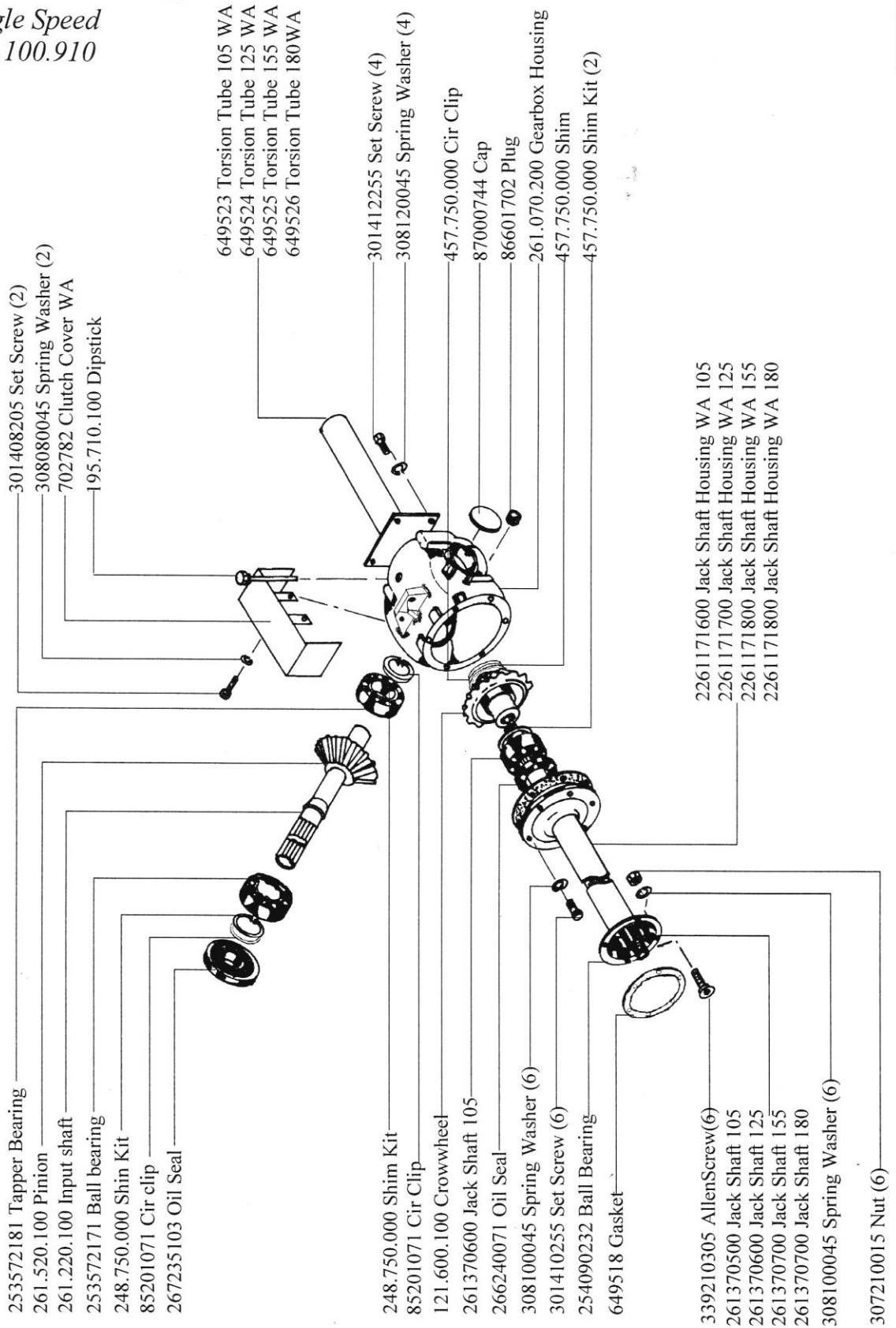

ROTAVATOR B-16 TRANSMISSION

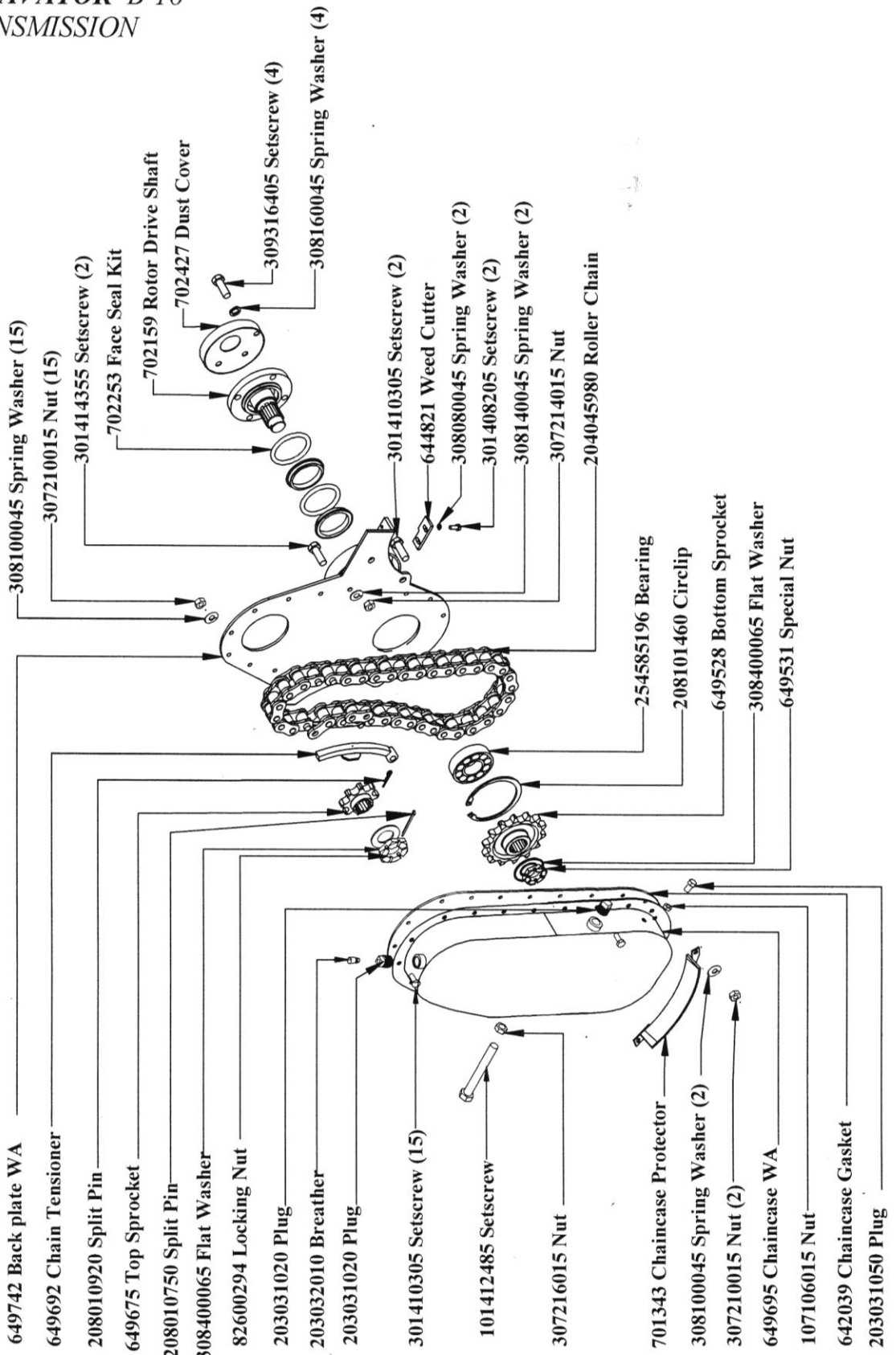

ROTAVATOR B-16

Stub Axle

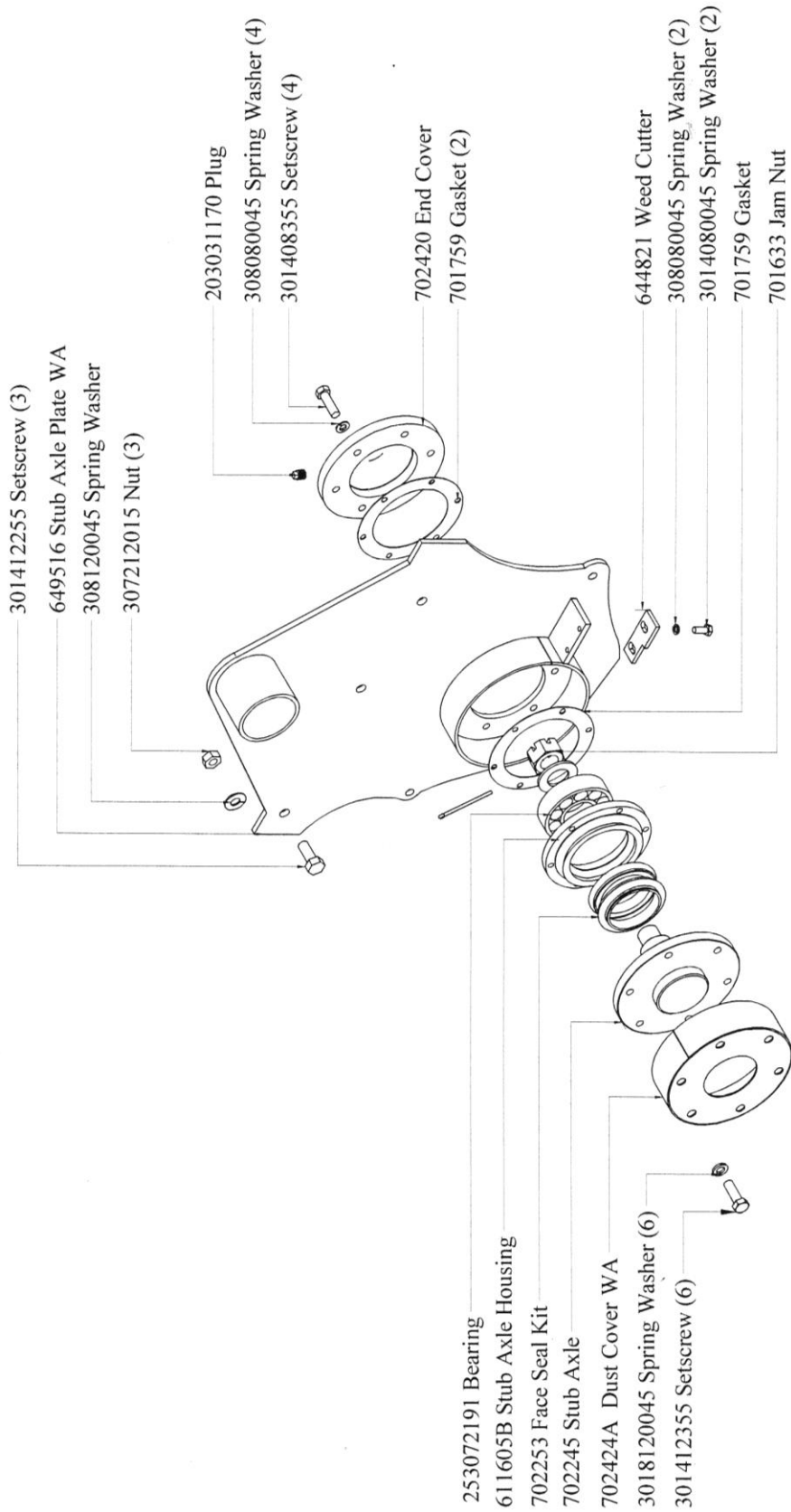

ROTAVATOR B-16

A Frame & Body

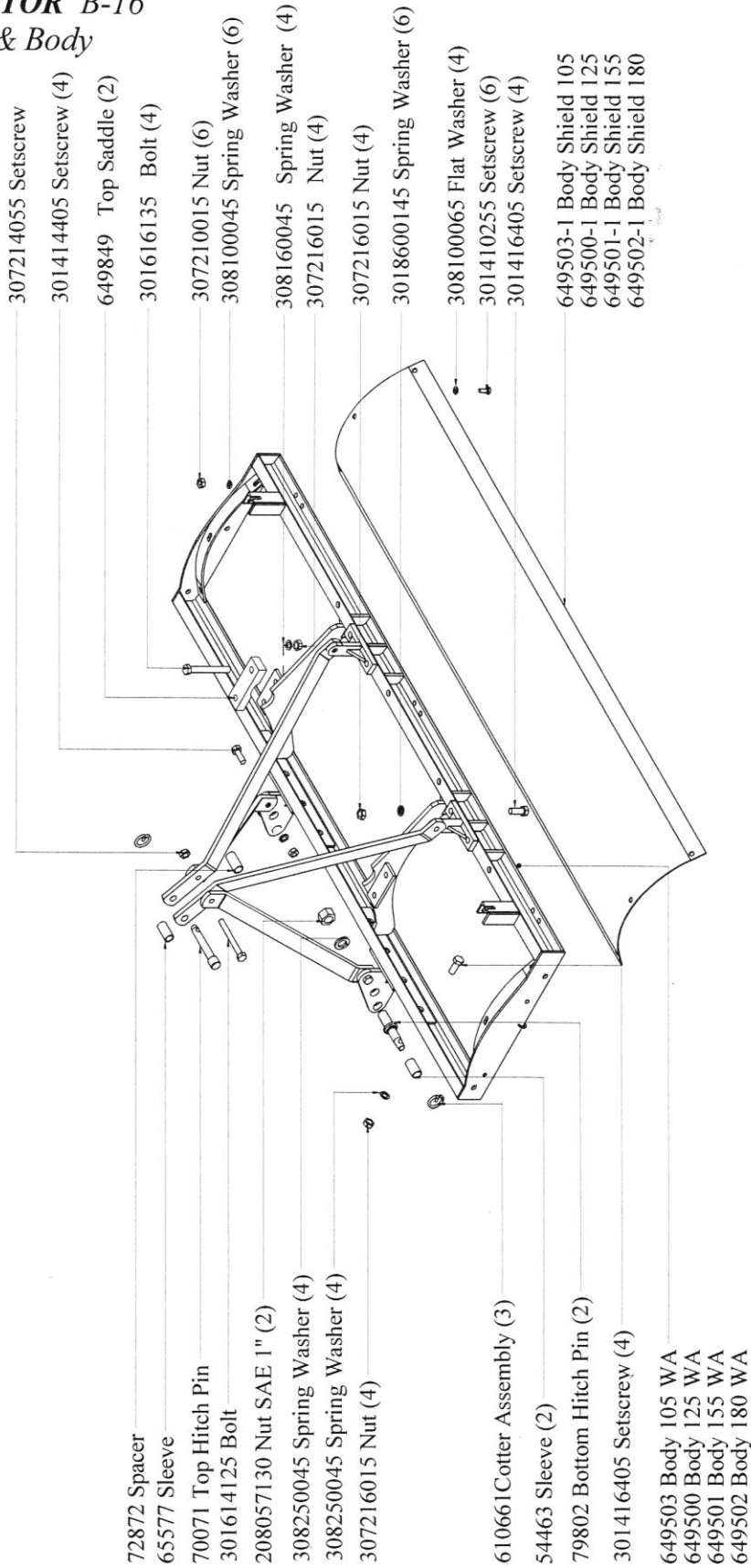

ROTAVATOR BUFFALO Rotor & Blades

MODEL	BLADE Part No.		Total Blade Quantity	Special Bolt Part No. 9844	Spring Washer Part No. 108081445	Special Nut Part No. 52053	Bolt, Washer, Nut, set 3903
	3900 L. HAND	3901 R. HAND					
649515 Rotor 105 WA	12	12	24	48	48	48	48sets
702191 Rotor 125 WA	15	15	30	60	60	60	60sets
702190 Rotor 155 WA	18	18	36	72	72	72	72sets
701145 Rotor 180 WA	21	21	42	84	84	84	84sets

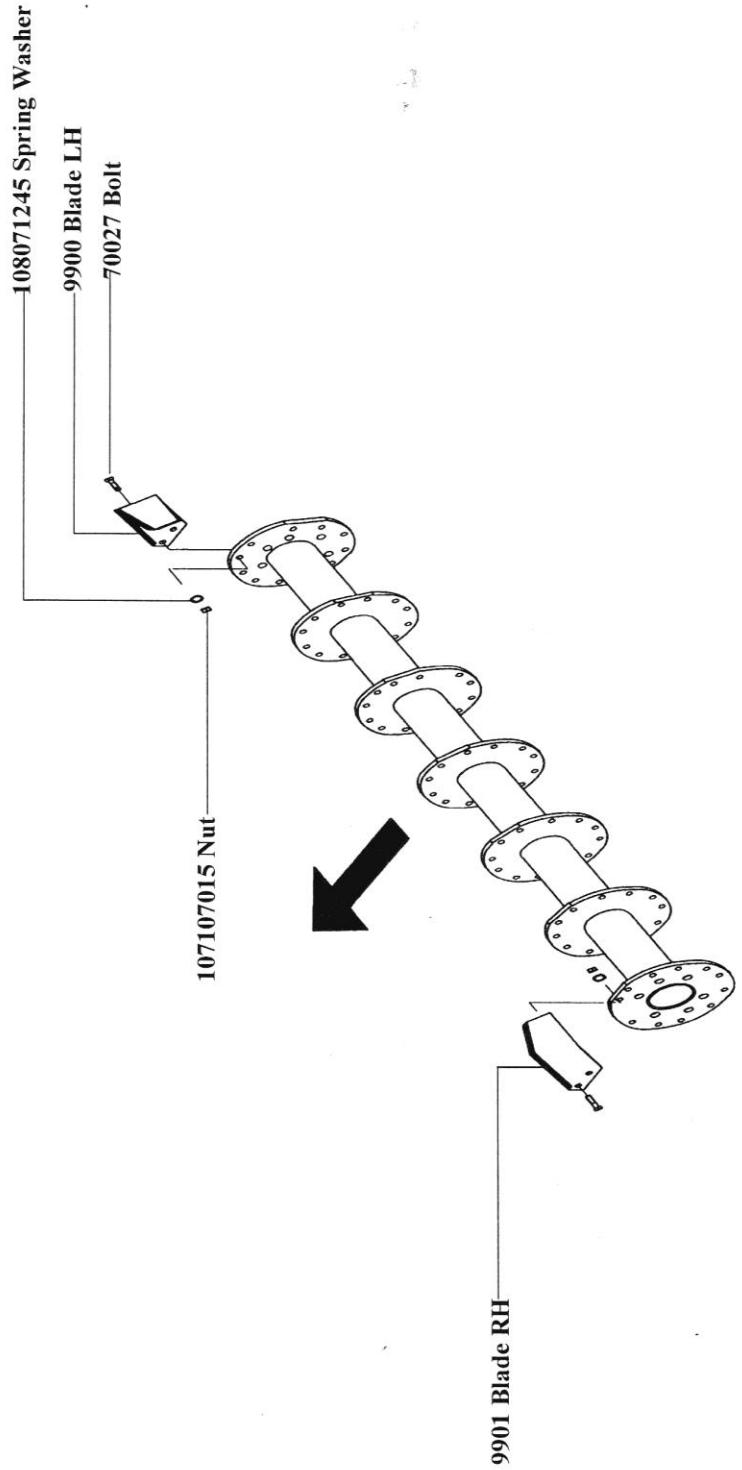

ROTAVATOR B-16
A Frame & Body

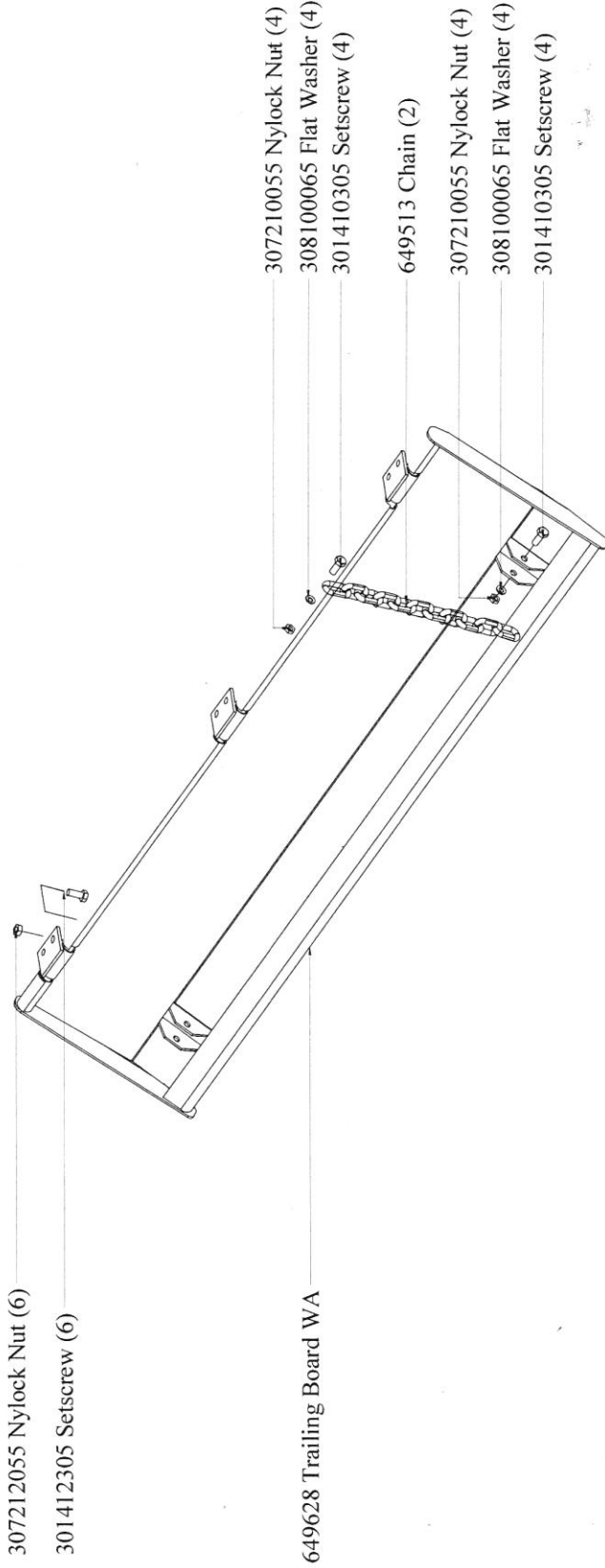

ROTAVATOR B-16 Skids

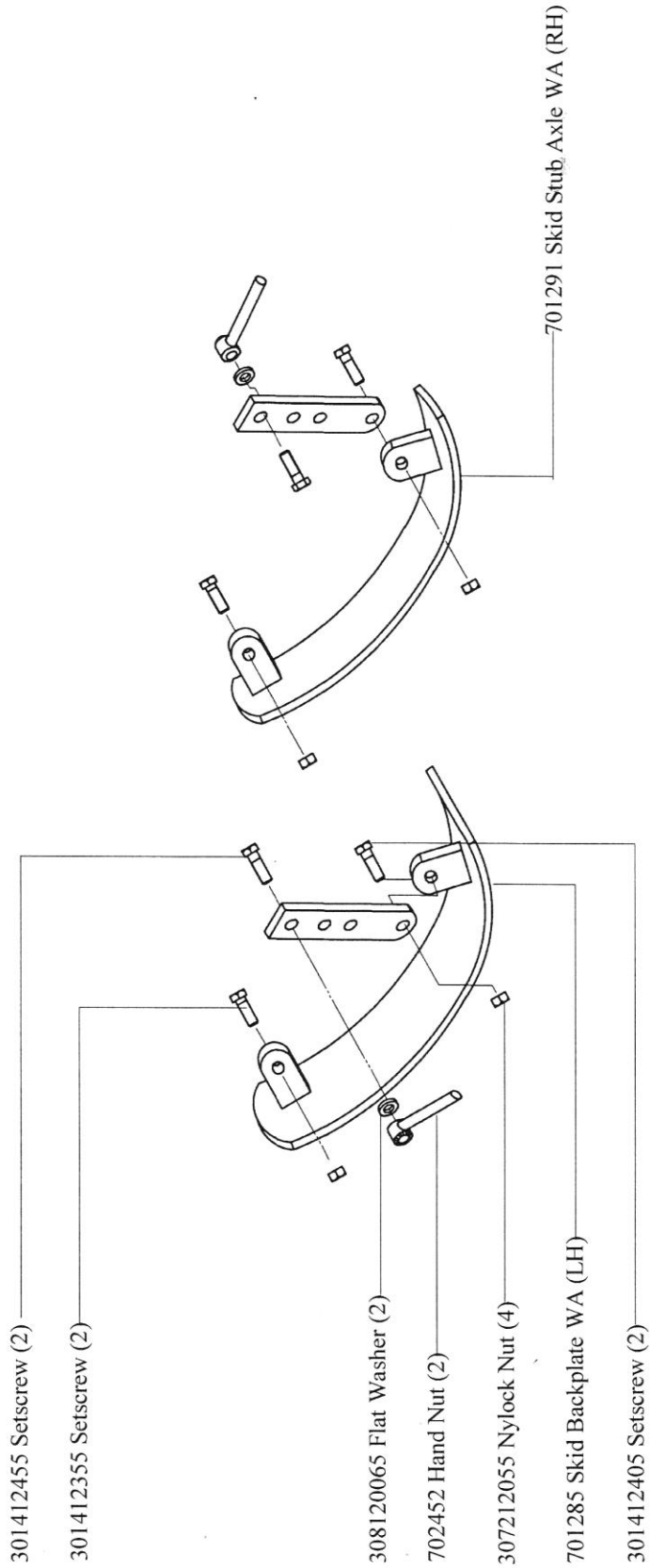

MAINTENANCE OF UNIVERSAL DRIVESHAFT

1. Recommended use high quality grease LITHIUM BASE (type NL G2).
2. Make sure to pump grease into the cross journal nipple until the grease came out from all cups.

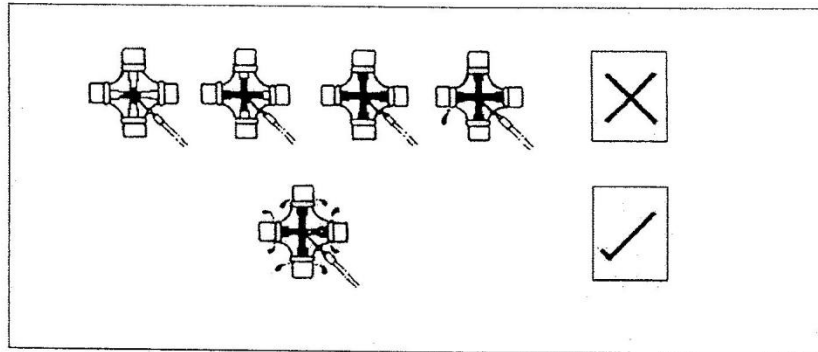

3. Make sure to dismantle both shaft assembly and then to brush at surface of inner and outer shaft with GRAPHITE POWDER OR MOLYBDENUM DISULPHIDE GREASE.
4. Difficulty to move the inner and outer shaft when operation will cause the serious damage to the shaft or output tractor shaft. If the surfaces of inner and outer shaft are dirty, we advise customer to clean it twice per day.

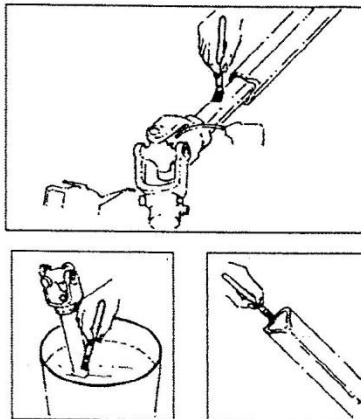

5. Please refer to the PTO owner's manual for further understanding.

HOWARD DEALERS & SPARE PART STOCKISTS

PERLIS PPN Perlis, Kangar Sin Keat Seng, Kangar PPK Mata Ayer, M.Ayer
KEDAH Nafas Jentera, A.S. Pertanian Utara, A.S. Sime Darby Ind, A.S. Hock Lean, Jitra TAE, Jitra TAE, Pendang Utara Agritrak, A.S.
PULAU PINANG Eik Seng, B'worth Kien Seng, B'worth Sime Darby Ind, S. Prai Sime Kubota, B'worth TCIM, B'worth UMW, B'worth
PERAK Benefarm, Ipoh Felera Process, Kg. Gajah PPN Perak, Ipoh Kej. Pertanian, T. Intan Overseas Union, T. intan Sime Kubota, T.Intan Sime Darby Ind, Ipoh TCIM, Ipoh UMW, Ipoh
SELANGOR BH Agri, K.L Palm Mach, Kepong Yik Soon, Kepong Teck Seng, Sg. Besi Puncak Emas, B. Caves S.J.I, Klang Asia Turfquip, P.J. Bar Formula, P.J. Mareqsee, P.J. Nafas Jentera, P.J. Eurostar, Puchong Minda Agri, Puchong Sime Darby Ind, Puchong Sime Kubota, Puchong Sin Hup Hin, Sekinchan MZZ Power, Shah Alam TCIM, Shah Alam UMW, Shah Alam

SABAH LSC K.K. Kong Seng, K.K. Lensoon, K.K. Palm Mach, K.K. Sime Kubota, K.K. Sin Ngiap, K.K. TCIE, K.K. Sime Darby, K.K. UMW, K.K. Wilpors, K.K. Win Hin, K.K. Sime Darby, Lahad Datu All Planters, Lahad Datu ATSB, Lahad Datu Benefarm, Lahad Datu Eurostar, Lahad Datu Palm Mach, Lahad Datu Nafas Jentera, Lahad Datu Sime Kubota, Lahad Datu Solid Firm, Lahad Datu TCIE, Lahad Datu Sime Darby, Labuan All Planters, Sandakan ATSB, Sandakan Benefarm, Sandakan Bri-Trail, Sandakan Eurostar, Sandakan Hup Seng, Sandakan Intan Karang, Sandakan TCIE, Sandakan Sime Darby, Sandakan Sime Kubota, Sandakan UMW, Sandakan Wilpros, Sandakan ATSB, Tawau Eurostar, Tawau LP Tractors, Tawau Sime Darby, Tawau UMW, Tawau
NEGERI SEMBILAN Bahau Auto, Bahau Emdek, Seremban TCIM, Seremban

MELAKA CS Agriparts, T.M. Jaya TCIM, T.M. Jaya Sime Darby, T.M. Jaya PPN Melaka, Melaka Segamat Agri, Krubong
JOHOR Asia Turfquip, J.B Hock Guan Hin, J.B. Seriintan, J.B. TCIM, J.B. Teck Seng, J.B. Sime Darby Inds, J.B. UMW, J.B. Ah Bee, Kluang Hiap Thye, Kluang Kang Sang, Kluang Kluang Berjaya, Kluang Maju Estate, Kluang Nafas Jentera, Kluang Palm Mach, Kluang Sime Darby Inds, Kluang Eurostar, Segamat Kian Huat, Segamat Segamat Cycle, Segamat Wabco, Skudai JVR, Ulu Tiram
KELANTAN Bogam, K.B Hock Hoe Hin, K.B. K.B. Jaya, K.B. Eurostar, G. Musang Palm Mach, G. Musang Lea Thong, K.B. Minda, K.B. Nafas Jentera, K.B. Sime Darby Inds, K.B. PPK K. Sepat, P.Mas Sime Kubota, W. Bharu

TERENGGANU J & J Machinery, K.T. KPT Peladang, K.T. K.T. Inds, K.T. Nafas Jentera, K.T. TADC, K.T. UMW, K.T.
PAHANG Yi Cheng, Gambang Eurostar, Kuantan Nafas Jentera, Kuantan Sime Kubota, Kuantan TCIM, Kuantan Tractors M'sia, Kuantan UMW, Kuantan M'tab Agri, Mentakab
SARAWAK Benefarm, Miri Sime Kubota, Miri TCM, Miri Sime Darby, Miri UMW, Miri Intan Karang, Bintulu Pan Sarawak, Bintulu Sime Kubota, Bintulu Sime Darby, Bintulu UMW, Bintulu Benefarm, Kuching JN Inds, Kuching Sime Kubota, Kuching TCIM, Kuching Sime Darby, Kuching UMW, Kuching Pan Sarawak, Sibul Sime Kubota, Sibul TCM, Sibul Sime Darby, Sibul Pansar, Sibul UMW, Sibul

BRUNEI Hock Hung Hing, BSB MPS Trading, BSB Tractors M'sia, BSB
INDONESIA Agrisarana Altrak 1978 Bina Pertiwi Pioneer Trading Probesco SAHABAT Agritama Satrindo Traktor Nusantara Capella, Medan SAHABAT, Medan
SINGAPORE ATS Tractors S'pore UMW
PHILIPPINES Alpha Machinery KAMPI Major Tractors, Davao Sime Darby Up-Town, Pasig City
THAILAND Phong La-or Patana Suptawee
INDIA Farm Implements
SRI LANKA Brown & Co. Hovael
BANGLADESH
TAIWAN
PAKISTAN
VIETNAM / CAMBODIA

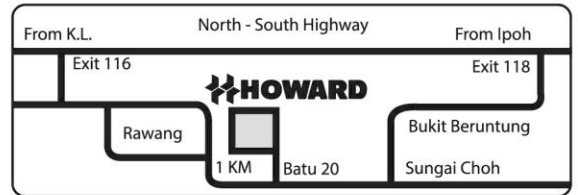

HOWARD is here to serve you

SALES & SERVICE



Noormah
Export & Shipping



Wan Ramli
Sales



Shafiq
Sales



Bala
Service Manager



Ismail
Service



C.K. Lim
Parts Manager

PARTS & PRODUCTION



Rafi
Production Manager



Ibrahim
Foreman Production



Maarof
Foreman Assembly



Keshal
Engineer



Yamin
Engineer



Samsol
Training & Demo

ADMINISTRATION & QA



Diana
Purchasing



Zamary
Store



Shukri
Draughtsman



Mustafa
Material QC



Haliza
Accounts



A. Nielsen
Managing Director



HOWARD

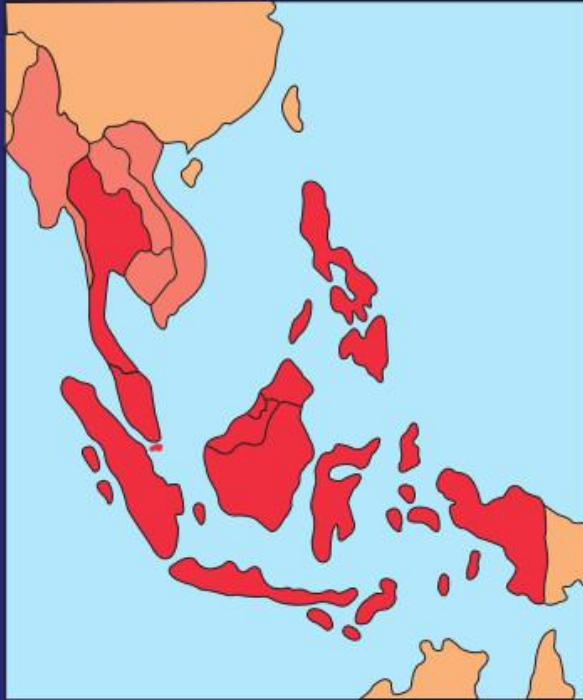

In Southeast Asia since 1962



Distributor :

HOWARD Alatpertanian Sdn. Bhd. (30189-A)

2, Jalan Perusahaan Tiga, Batu 20,
48000 Rawang, Selangor Darul Ehsan, Malaysia.

Tel : 603 - 6093 1010

Fax : 603 - 6092 1010

e-mail : howardmy@tm.net.my

www.howardmy.com